



1-OF-10 DECODER/DRIVER OPEN-COLLECTOR

The SN54/74LS145, 1-of-10 Decoder/Driver, is designed to accept BCD inputs and provide appropriate outputs to drive 10-digit incandescent displays. All outputs remain off for all invalid binary input conditions. It is designed for use as indicator/relay drivers or as an open-collector logic circuit driver. Each of the high breakdown output transistors will sink up to 80 mA of current. Typical power dissipation is 35 mW. This device is fully compatible with all TTL families.

- Low Power Version of 54/74145
- Input Clamp Diodes Limit High Speed Termination Effects

CONNECTION DIAGRAM DIP (TOP VIEW)

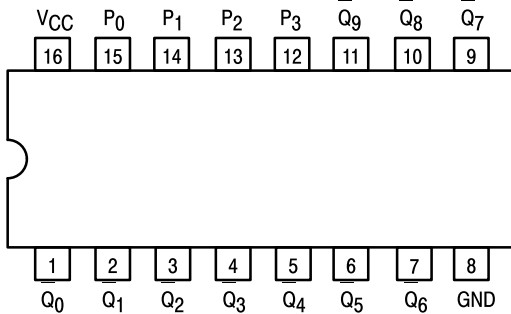

PIN NAMES

P_0, P_1, P_2, P_3 BCD Inputs
 Q_0 to Q_9 Outputs (Note b)

LOADING (Note a)

	HIGH	LOW
Open Collector	0.5 U.L.	0.25 U.L.
		15 (7.5) U.L.

NOTES:

- a) 1 TTL Unit Load (U.L.) = 40 μ A HIGH/1.6 mA LOW.
- b) The Output LOW drive factor is 2.5 U.L. for Military (54) and 15 U.L. for Commercial (74) Temperature Ranges.

LOGIC DIAGRAM

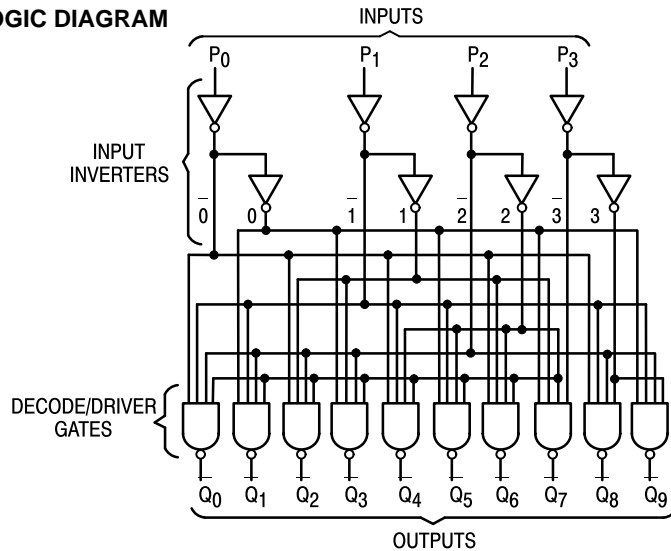

SN54/74LS145

1-OF-10 DECODER/DRIVER OPEN-COLLECTOR LOW POWER SCHOTTKY

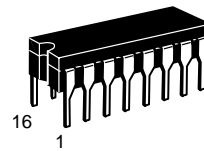

J SUFFIX
 CERAMIC
 CASE 620-09

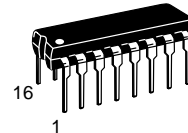

N SUFFIX
 PLASTIC
 CASE 648-08

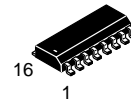

D SUFFIX
 SOIC
 CASE 751B-03

ORDERING INFORMATION

- SN54LSXXXJ Ceramic
- SN74LSXXXN Plastic
- SN74LSXXXD SOIC

LOGIC SYMBOL

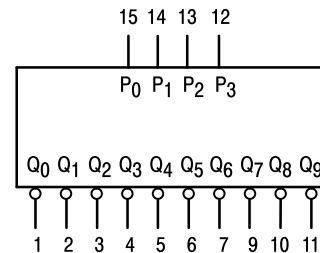

VCC = PIN 16
 GND = PIN 8

SN54/74LS145

TRUTH TABLE

INPUTS				OUTPUTS									
P ₃	P ₂	P ₁	P ₀	Q ₀	Q ₁	Q ₂	Q ₃	Q ₄	Q ₅	Q ₆	Q ₇	Q ₈	Q ₉
L	L	L	L	L	H	H	H	H	H	H	H	H	H
L	L	L	H	H	L	H	H	H	H	H	H	H	H
L	L	H	L	H	H	L	H	H	H	H	H	H	H
L	L	H	H	H	H	H	L	H	H	H	H	H	H
L	H	L	L	H	H	H	H	L	H	H	H	H	H
L	H	L	H	H	H	H	H	H	L	H	H	H	H
L	H	H	L	H	H	H	H	H	H	L	H	H	H
L	H	H	H	H	H	H	H	H	H	H	L	H	H
H	L	L	L	H	H	H	H	H	H	H	H	L	H
H	L	L	H	H	H	H	H	H	H	H	H	H	L
H	L	H	L	H	H	H	H	H	H	H	H	H	H
H	L	H	H	H	H	H	H	H	H	H	H	H	H
H	H	L	L	H	H	H	H	H	H	H	H	H	H
H	H	L	H	H	H	H	H	H	H	H	H	H	H
H	H	H	L	H	H	H	H	H	H	H	H	H	H
H	H	H	H	H	H	H	H	H	H	H	H	H	H

H = HIGH Voltage Level
L = LOW Voltage Level

GUARANTEED OPERATING RANGES

Symbol	Parameter		Min	Typ	Max	Unit
V _{CC}	Supply Voltage	54	4.5	5.0	5.5	V
		74	4.75	5.0	5.25	
T _A	Operating Ambient Temperature Range	54	-55	25	125	°C
		74	0	25	70	
V _{OH}	Output Voltage — High	54, 74			15	V
I _{OL}	Output Current — Low	54			12	mA
		74			24	

SN54/74LS145

DC CHARACTERISTICS OVER OPERATING TEMPERATURE RANGE (unless otherwise specified)

Symbol	Parameter	Limits			Unit	Test Conditions
		Min	Typ	Max		
V_{IH}	Input HIGH Voltage	2.0			V	Guaranteed Input HIGH Voltage for All Inputs
V_{IL}	Input LOW Voltage	54		0.7	V	Guaranteed Input LOW Voltage for All Inputs
		74		0.8		
V_{IK}	Input Clamp Diode Voltage		-0.65	-1.5	V	$V_{CC} = \text{MIN}$, $I_{IN} = -18 \text{ mA}$
I_{OH}	Output HIGH Current	54, 74		250	μA	$V_{CC} = \text{MIN}$, $V_{OH} = \text{MAX}$
V_{OL}	Output LOW Voltage	54, 74	0.25	0.4	V	$V_{CC} = V_{CC} \text{ MIN}$, $V_{IN} = V_{IL} \text{ or } V_{IH}$ per Truth Table
		74	0.35	0.5	V	
		54, 74	2.3	3.0	V	
I_{IH}	Input HIGH Current			20	μA	$V_{CC} = \text{MAX}$, $V_{IN} = 2.7 \text{ V}$
				0.1	mA	$V_{CC} = \text{MAX}$, $V_{IN} = 7.0 \text{ V}$
I_{IL}	Input LOW Current			-0.4	mA	$V_{CC} = \text{MAX}$, $V_{IN} = 0.4 \text{ V}$
I_{CC}	Power Supply Current			13	mA	$V_{CC} = \text{MAX}$, $V_{IN} = \text{GND}$

AC CHARACTERISTICS ($T_A = 25^\circ\text{C}$)

Symbol	Parameter	Limits			Unit	Test Conditions
		Min	Typ	Max		
t_{PHL}	Propagation Delay P_n Input to Q_n Output			50	ns	$V_{CC} = 5.0 \text{ V}$ $C_L = 45 \text{ pF}$
t_{PLH}				50		

AC WAVEFORMS

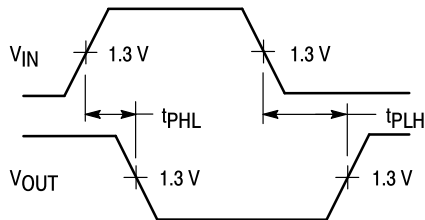

Figure 1

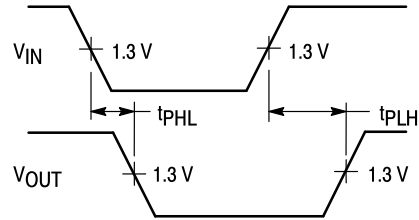

Figure 2

**Case 751B-03 D Suffix
16-Pin Plastic
SO-16**



- NOTES:
1. DIMENSIONING AND TOLERANCING PER ANSI Y14.5M, 1982.
 2. CONTROLLING DIMENSION: MILLIMETER.
 3. DIMENSION A AND B DO NOT INCLUDE MOLD PROTRUSION.
 4. MAXIMUM MOLD PROTRUSION 0.15 (0.006) PER SIDE.
 5. 751B-01 IS OBSOLETE, NEW STANDARD 751B-03.

DIM	MILLIMETERS		INCHES	
	MIN	MAX	MIN	MAX
A	9.80	10.00	0.386	0.393
B	3.80	4.00	0.150	0.157
C	1.35	1.75	0.054	0.068
D	0.35	0.49	0.014	0.019
F	0.40	1.25	0.016	0.049
G	1.27 BSC		0.050 BSC	
J	0.19	0.25	0.008	0.009
K	0.10	0.25	0.004	0.009
M	0°	7°	0°	7°
P	5.80	6.20	0.229	0.244
R	0.25	0.50	0.010	0.019

**Case 648-08 N Suffix
16-Pin Plastic**



- NOTES:
1. DIMENSIONING AND TOLERANCING PER ANSI Y14.5M, 1982.
 2. CONTROLLING DIMENSION: INCH.
 3. DIMENSION "L" TO CENTER OF LEADS WHEN FORMED PARALLEL.
 4. DIMENSION "B" DOES NOT INCLUDE MOLD FLASH.
 5. ROUNDED CORNERS OPTIONAL.
 6. 648-01 THRU -07 OBSOLETE, NEW STANDARD 648-08.

DIM	MILLIMETERS		INCHES	
	MIN	MAX	MIN	MAX
A	18.80	19.55	0.740	0.770
B	6.35	6.85	0.250	0.270
C	3.69	4.44	0.145	0.175
D	0.39	0.53	0.015	0.021
F	1.02	1.77	0.040	0.070
G	2.54 BSC		0.100 BSC	
H	1.27 BSC		0.050 BSC	
J	0.21	0.38	0.008	0.015
K	2.80	3.30	0.110	0.130
L	7.50	7.74	0.295	0.305
M	0°	10°	0°	10°
S	0.51	1.01	0.020	0.040

**Case 620-09 J Suffix
16-Pin Ceramic Dual In-Line**

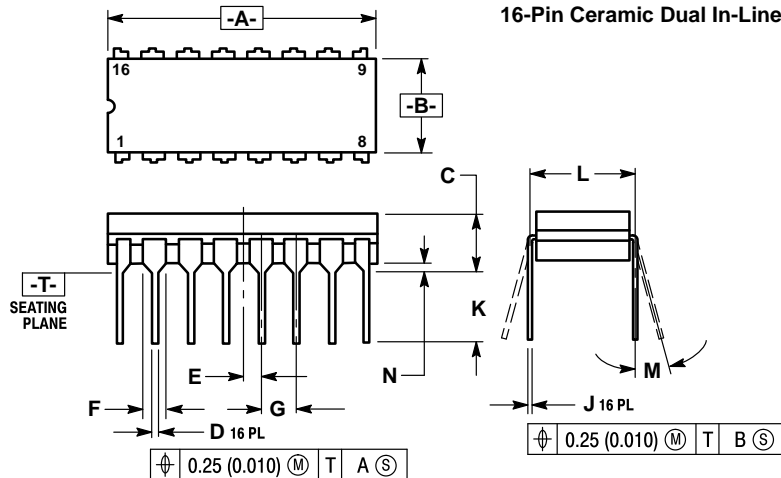

- NOTES:
1. DIMENSIONING AND TOLERANCING PER ANSI Y14.5M, 1982.
 2. CONTROLLING DIMENSION: INCH.
 3. DIMENSION L TO CENTER OF LEAD WHEN FORMED PARALLEL.
 4. DIM F MAY NARROW TO 0.76 (0.030) WHERE THE LEAD ENTERS THE CERAMIC BODY.
 5. 620-01 THRU -08 OBSOLETE, NEW STANDARD 620-09.

DIM	MILLIMETERS		INCHES	
	MIN	MAX	MIN	MAX
A	19.05	19.55	0.750	0.770
B	6.10	7.36	0.240	0.290
C	—	4.19	—	0.165
D	0.39	0.53	0.015	0.021
E	1.27 BSC		0.050 BSC	
F	1.40	1.77	0.055	0.070
G	2.54 BSC		0.100 BSC	
J	0.23	0.27	0.009	0.011
K	—	5.08	—	0.200
L	7.62 BSC		0.300 BSC	
M	0°	15°	0°	15°
N	0.39	0.88	0.015	0.035

Motorola reserves the right to make changes without further notice to any products herein. Motorola makes no warranty, representation or guarantee regarding the suitability of its products for any particular purpose, nor does Motorola assume any liability arising out of the application or use of any product or circuit, and specifically disclaims any and all liability, including without limitation consequential or incidental damages. "Typical" parameters can and do vary in different applications. All operating parameters, including "Typicals" must be validated for each customer application by customer's technical experts. Motorola does not convey any license under its patent rights nor the rights of others. Motorola products are not designed, intended, or authorized for use as components in systems intended for surgical implant into the body, or other applications intended to support or sustain life, or for any other application in which the failure of the Motorola product could create a situation where personal injury or death may occur. Should Buyer purchase or use Motorola products for any such unintended or unauthorized application, Buyer shall indemnify and hold Motorola and its officers, employees, subsidiaries, affiliates, and distributors harmless against all claims, costs, damages, and expenses, and reasonable attorney fees arising out of, directly or indirectly, any claim of personal injury or death associated with such unintended or unauthorized use, even if such claim alleges that Motorola was negligent regarding the design or manufacture of the part. Motorola and  are registered trademarks of Motorola, Inc. Motorola, Inc. is an Equal Opportunity/Affirmative Action Employer.

Literature Distribution Centers:

USA: Motorola Literature Distribution; P.O. Box 20912; Phoenix, Arizona 85036.

EUROPE: Motorola Ltd.; European Literature Centre; 88 Tanners Drive, Blakelands, Milton Keynes, MK14 5BP, England.

JAPAN: Nippon Motorola Ltd.; 4-32-1, Nishi-Gotanda, Shinagawa-ku, Tokyo 141, Japan.

ASIA PACIFIC: Motorola Semiconductors H.K. Ltd.; Silicon Harbour Center, No. 2 Dai King Street, Tai Po Industrial Estate, Tai Po, N.T., Hong Kong.



This datasheet has been download from:

www.datasheetcatalog.com

Datasheets for electronics components.